

LEGEND

- M1 SYCAMORE VENEER & EDGING
- M2 SYCAMORE VENEER & EDGING
- S1 SUPER WHITE STONE
- S2 BIANCO NEVE STONE
- M3 CLEAR ANODIZED ETCHED ALUMINUM
- G1 CLEAR, LOW IRON GLASS
- G2 CLEAR, LOW IRON MIRROR
- P1 VENETIAN PLASTER

GENERAL NOTES

1. CABINET PULLS ARE TO BE CUSTOM EDGE PULLS AS SHOWN ON DRAWINGS. ALUMINUM FINISH TO MATCH PROJECT STANDARD.
2. ALUM. GRILLS AT CABINET BASES TO BE 1/8" x 1/8" SPACE CONTINUOUS ANODIZED WITH CONCEALED FASTENING.

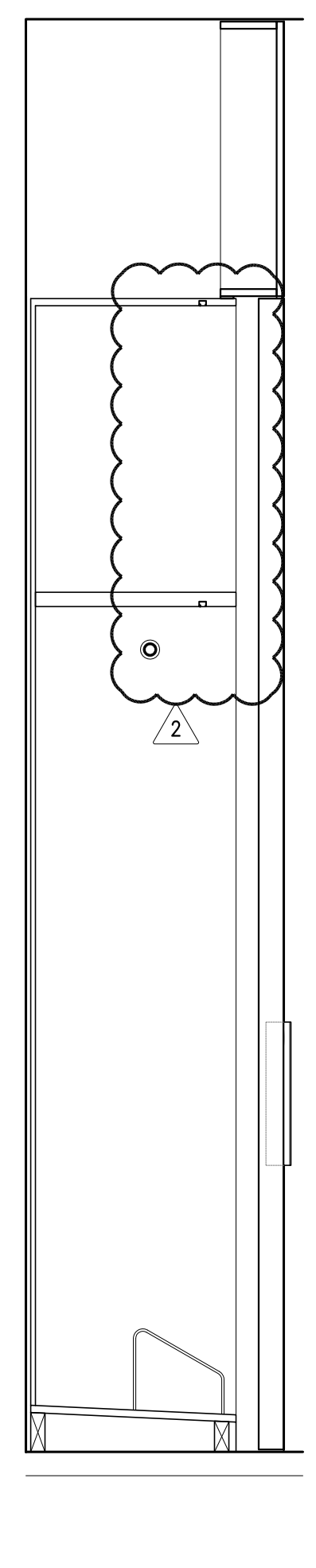

7 ELEVATION
3/4"=1'-0"

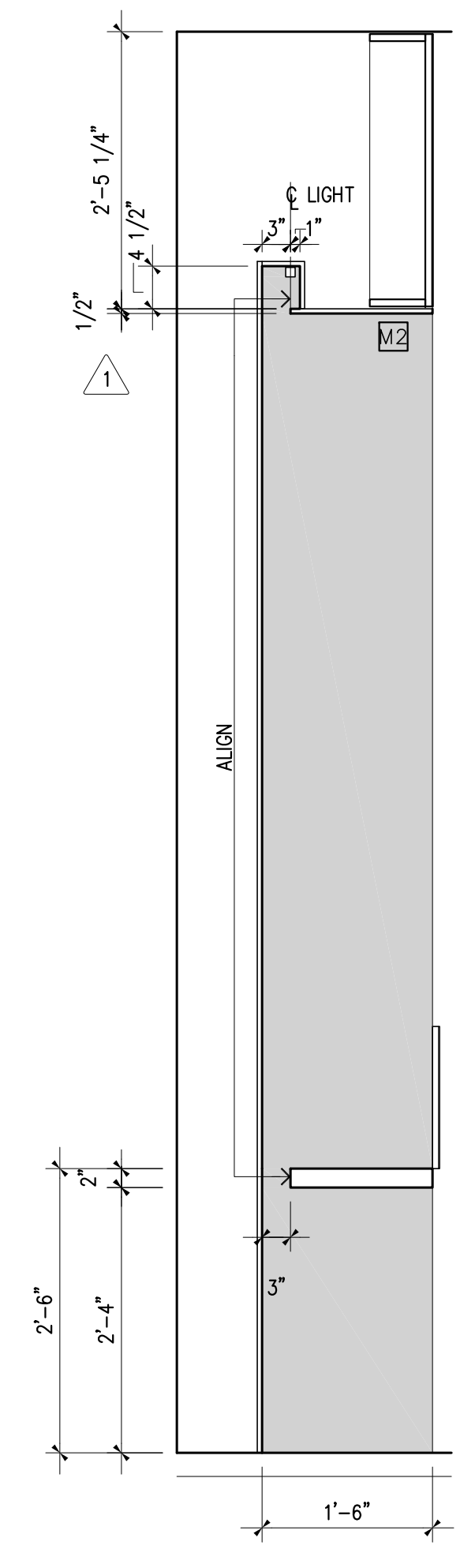

6 ELEVATION
3/4"=1'-0"

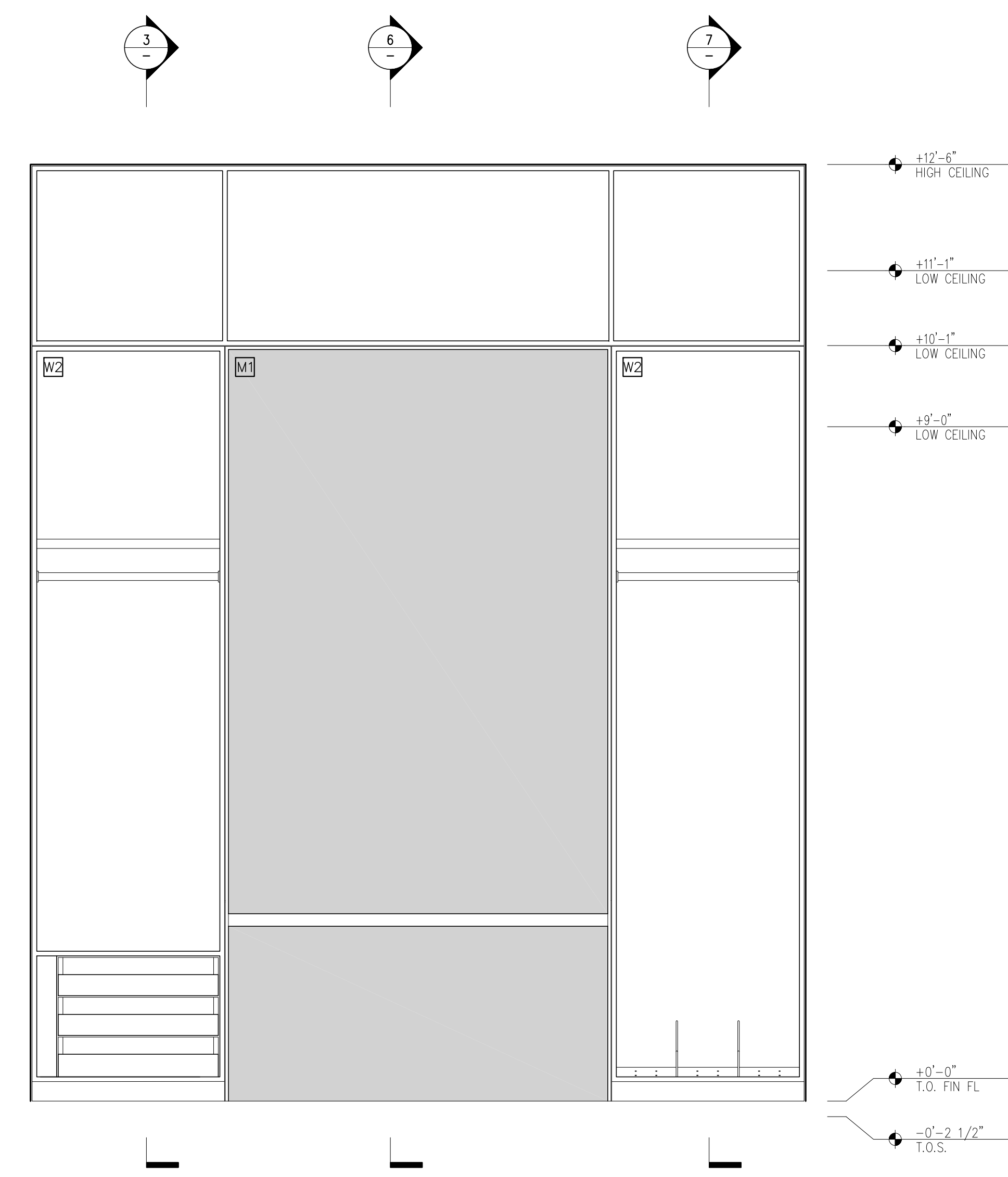

5 ELEVATION
3/4"=1'-0"

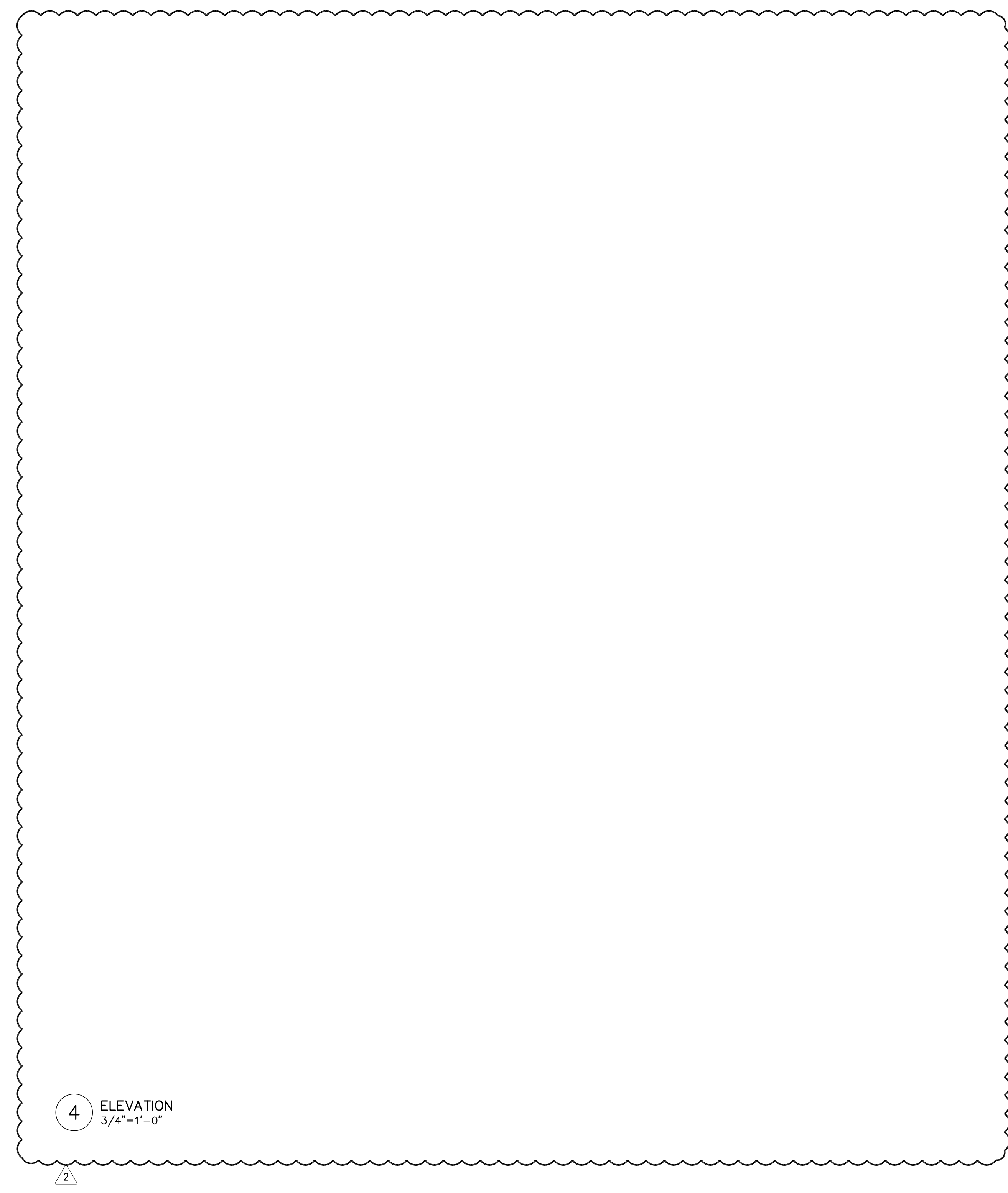

4 ELEVATION
3/4"=1'-0"

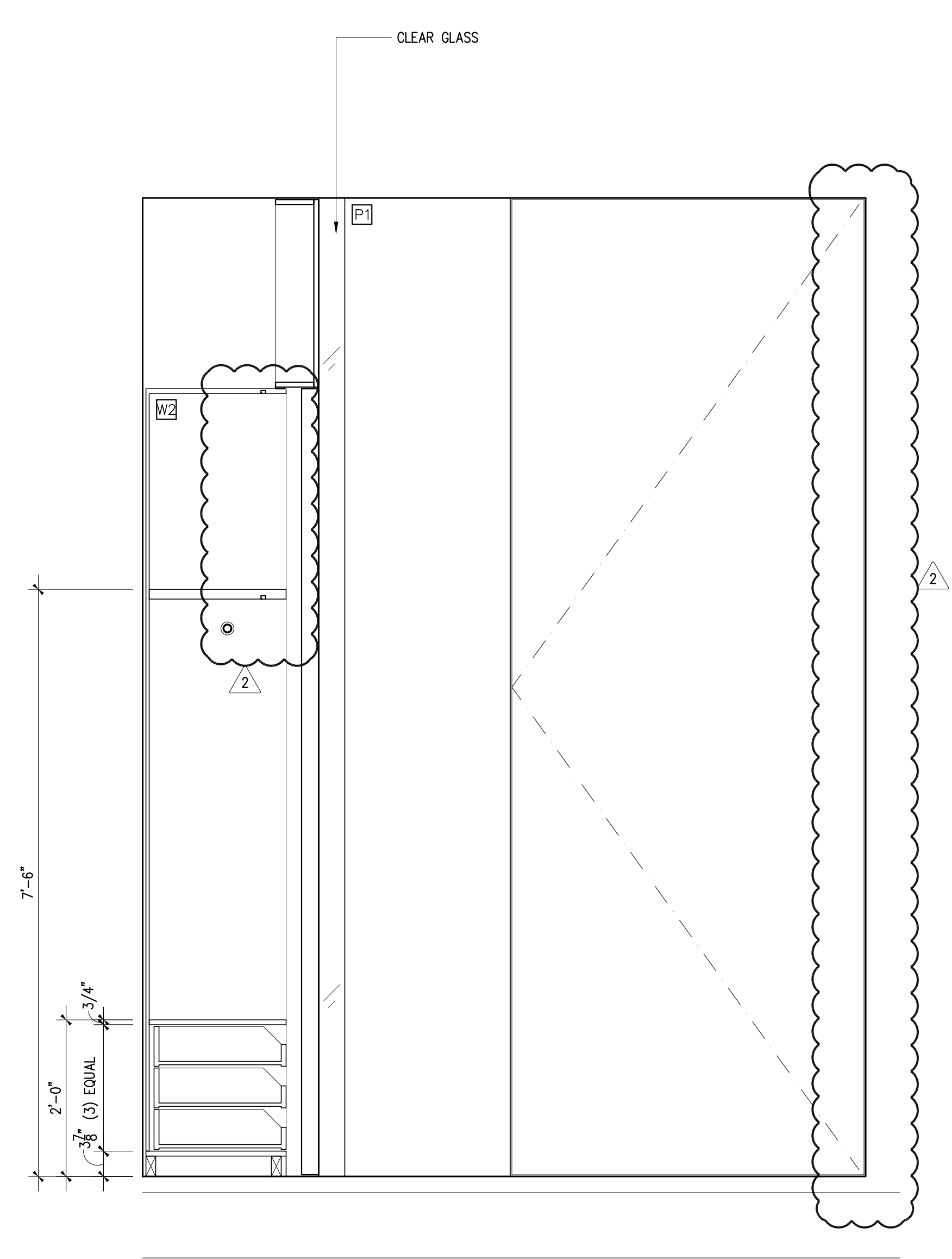

3 ELEVATION
3/4"=1'-0"

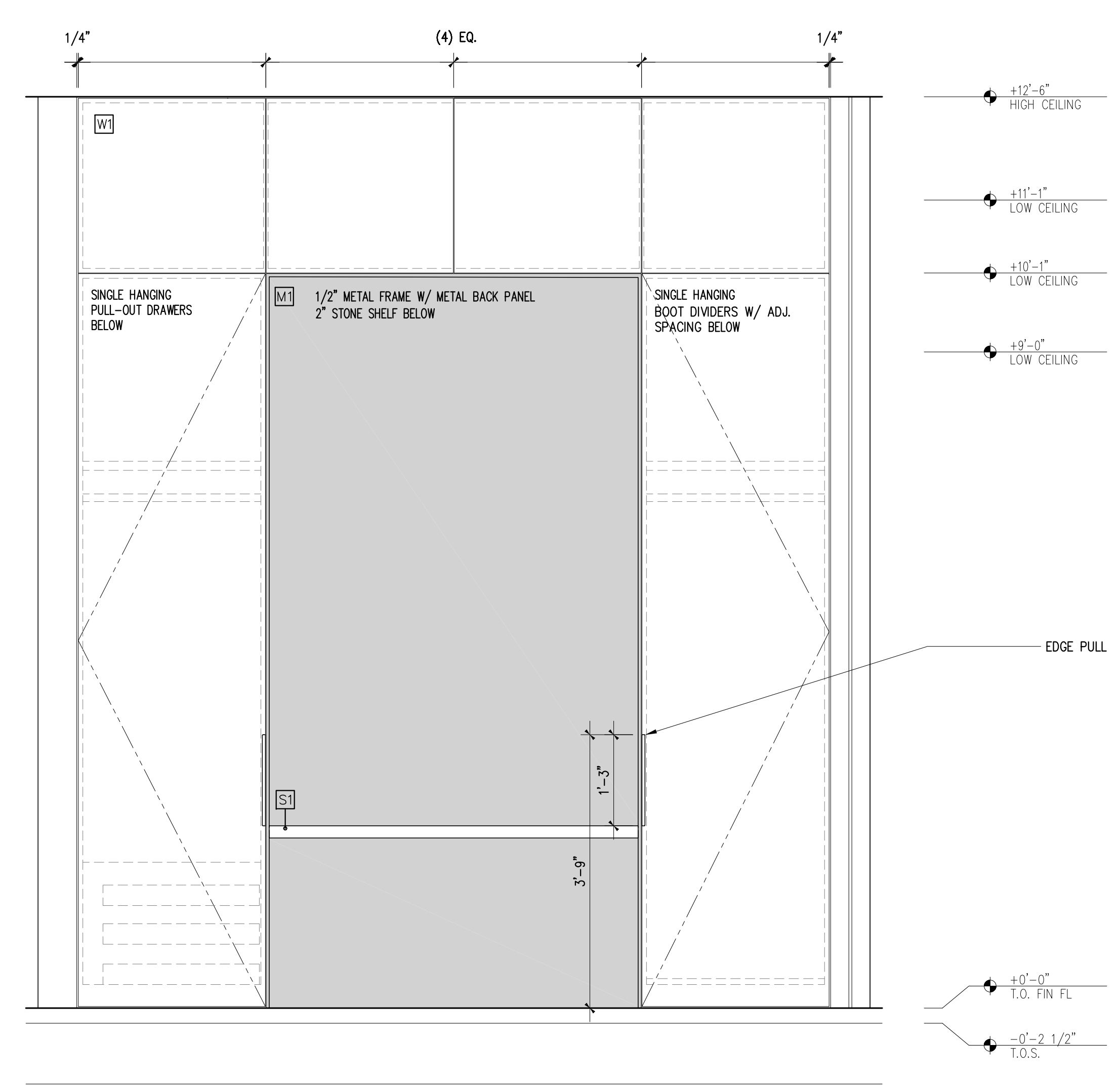

2 ELEVATION
3/4"=1'-0"

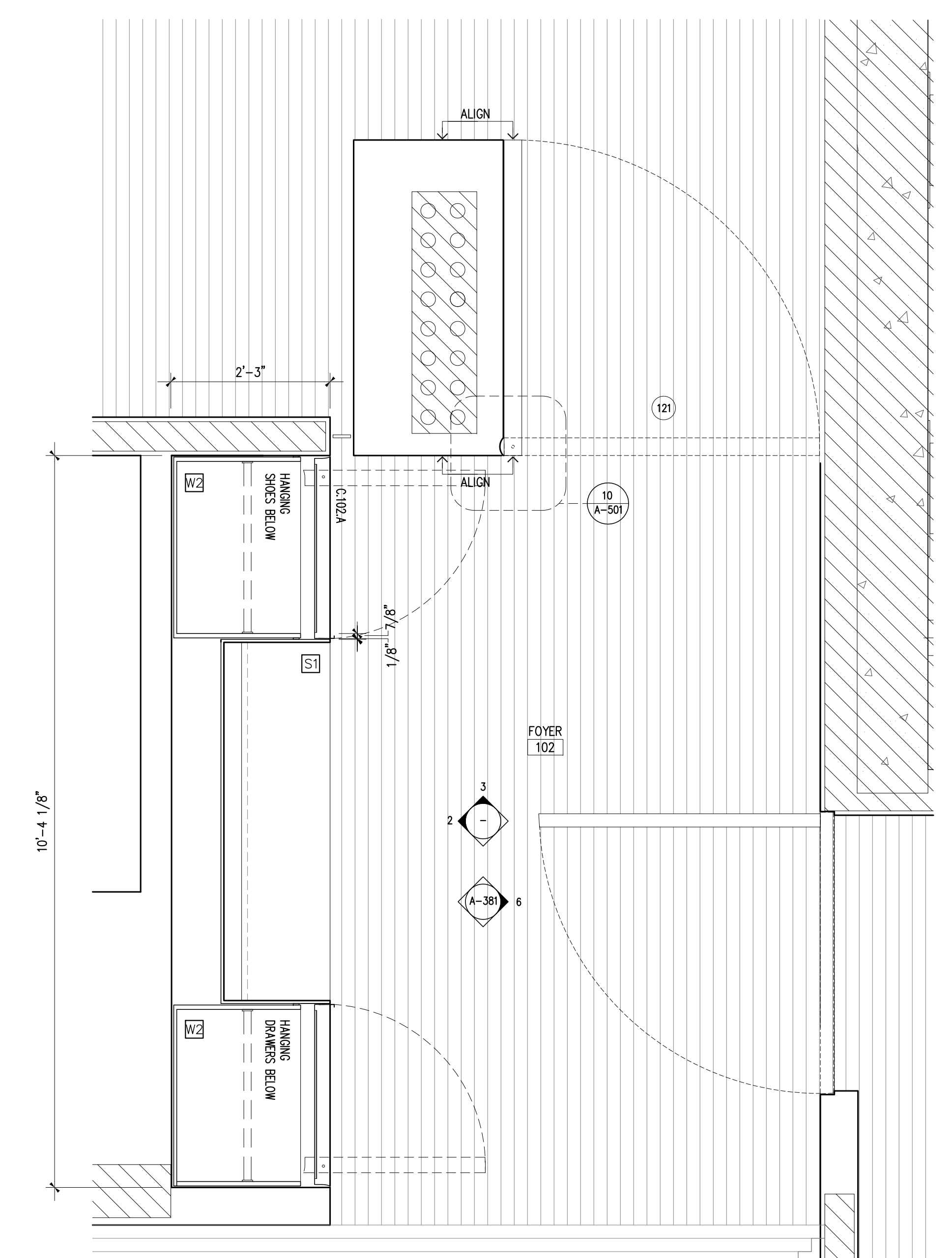

1 DETAIL PLAN
3/4"=1'-0"

No.	Date	Issues/Revisions
26	JAN 2015	REVISIONS AS BUBBLED
15	NOV 2015	REVISIONS AS BUBBLED
04	AUG 2017	CABINET PULLS REVISED FOR PRICING

432 PARK, APT. 78B
432 PARK AVENUE, 61ST FLOOR NEW YORK, NY 10022

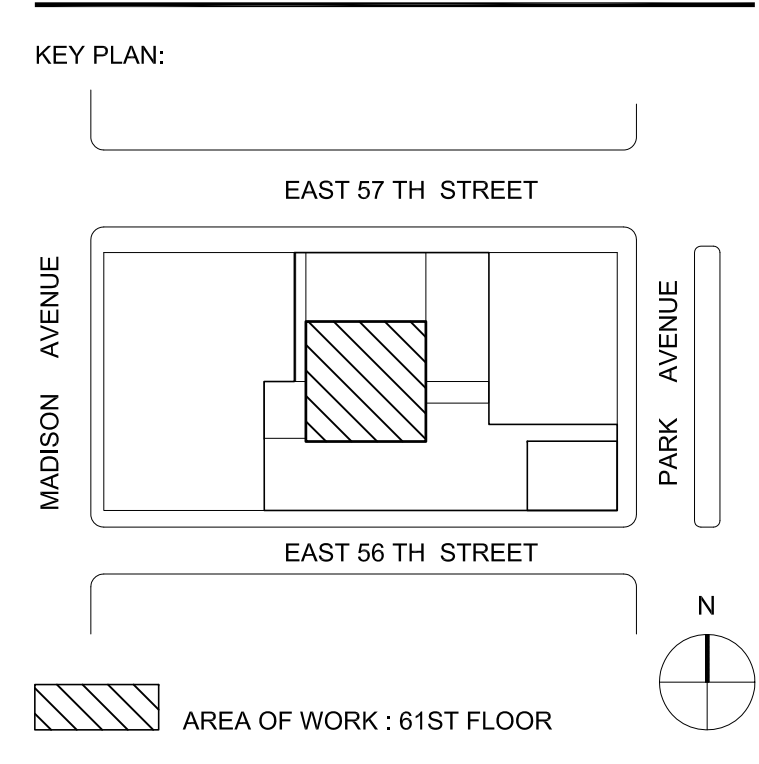

KANG MODERN
architect + design
NEW YORK office
304 Hudson Street, Suite 500
New York, NY 10013
T 212.462.2028
F 212.462.4788

WSP Flack & Kurtz
312 Seventh Avenue
New York, NY 10018
ME/P Engineers
Tel: (212) 535-9600

JDL/C. Architectural Lighting design
10 East 28th Street, 5th Floor
New York, NY 10016
Lighting Designers
Tel: (212) 536-7800

FOYER PLAN, ELEVATIONS, & SECTIONS

Scale: 3/4"=1'-0"
Date: 25 JAN 2017 **A-321**

18248 SHEETS - SCALE IS FINAL WORKING SCALE
 18249 SHEETS - SCALE IS 1/2" WORKING SCALE
 18250 SHEETS - INTS